

RADIANT GRILLER 6 BURNER



MANUFACTURING
SINCE 1966

Model: GGA4006 - FREE STANDING



FEATURES

- New improved higher performance
- Powerful efficient burners
- Quality gas valves
- Stainless Steel integrated splash guard
- Base with storage shelf
- Flat grill plates available as an optional extra
- Stainless steel drip tray
- Die cast metal control knobs
- Rear castors for easier cleaning access
- Cast iron radiants for maximum heat retention
- 16000 BTU per burner

NOTE:

- Heavy duty gas products to be connected by approved gas installer
- Drip tray included



ALL ANVIL EQUIPMENT COMES WITH A TWO YEAR WARRANTY ON COMPONENTS AND DEFECTIVE WORKMANSHIP.

www.anvilworld.com

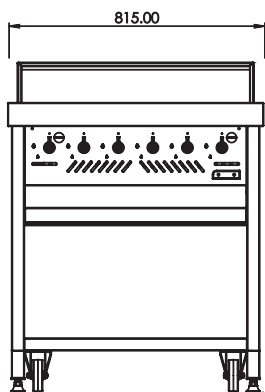
Model: GGA4006

SPECIFICATIONS

OUTPUT	96 000 BTU
PACKAGING (W x D x H)	850 x 580 x 1165 (mm)
UNIT (W x D x H)	815 x 740 x 1050 (mm)
NET WEIGHT	75kg
GROSS WEIGHT	85kg
SHIPPING VOLUME	0.57m ³
SURFACE	Ribbed Grates
GRID AREA	680 x 470 (mm)
REGULATOR	No

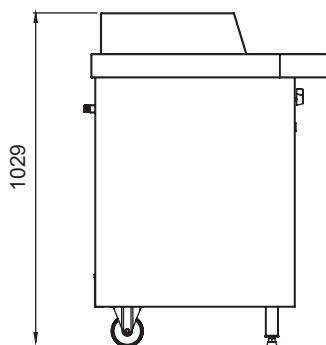
AVAILABLE IN

 LPG | Ngas

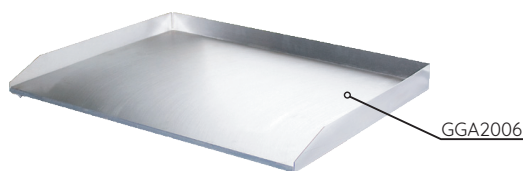
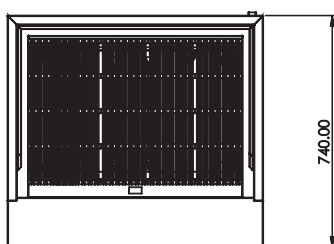
OPTIONAL EXTRAS
GRILL PLATE

CODE	DESCRIPTION
GGA2006	Grill Plate for 6 Burner

NOTE

- When viewing the appliance from the front in its usual operating position, the width (W) of the product is the total distance from left to right; the depth (D) of the product is the total distance from the front to the back; the height (H) is the total distance from the bottom of the product to the top. Pictures may vary from actual product.

DISCLAIMER

- Output performance figures quoted are dependent on various factors. Anvil reserves the right, without notice, to make changes and revisions to product specifications, materials and design, when we believe it will provide better performance, durability, and efficiency. Unit measurements may vary depending on point of reference.

ALL ANVIL EQUIPMENT COMES WITH A TWO YEAR WARRANTY ON COMPONENTS AND DEFECTIVE WORKMANSHIP.
www.anvilworld.com